

1 PANEL ON WOOD FURRING

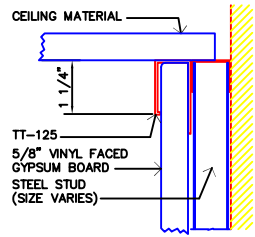

2 PANEL ON STUD

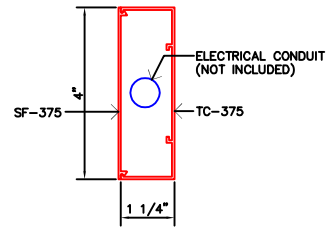

3 THROUGH POST

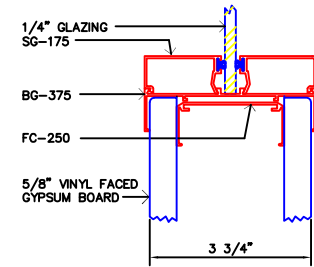

4 SILL / GLAZING

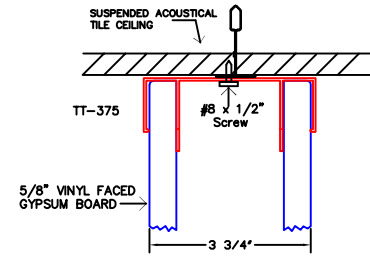

5 HEAD CONDITION FULL OR RAIL HEIGHT

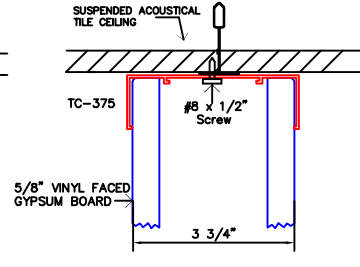

6 CEILING HEAD CONDITION

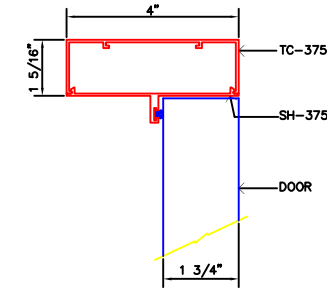

7 FULL HEIGHT DOOR FRAME WITH STANDARD SNAP HEADER

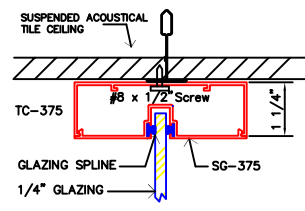

8 GLAZED HEAD AT CEILING

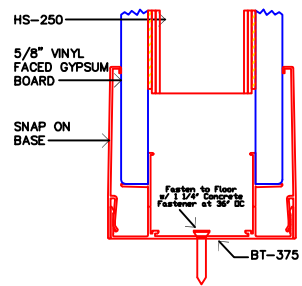

9 FLOOR CONDITION

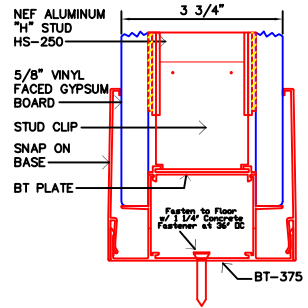

10 FLOOR CONDITION STUD WITH STUD CLIP

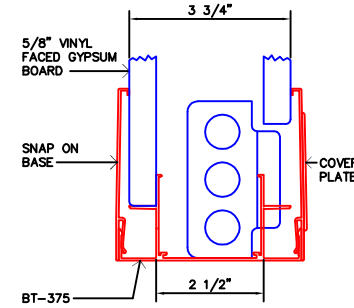

11 FLOOR CONDITION INTEGRAL CLIP ON BASE

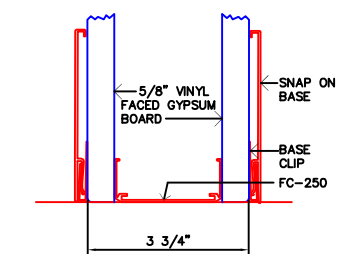

12 FLOOR CONDITION CLIP ON BASE W/ CLIP

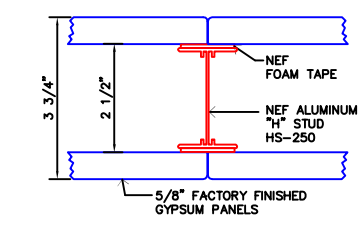

13 PARTITION JOINT/NEF ALUMINUM "H" STUD

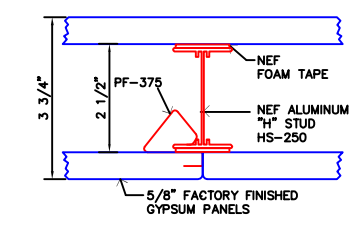

14 PARTITION JOINT/NEF ALUMINUM "H" STUD WITH NON-PROGRESSIVE EDGE CLIP STAGGERED JOINT

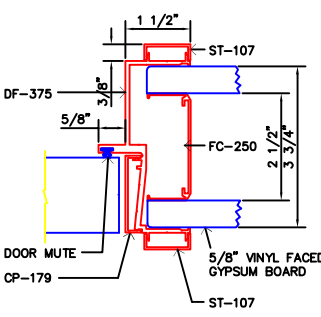

15 DOOR JAMB AND HEADER SOLID PARTITION

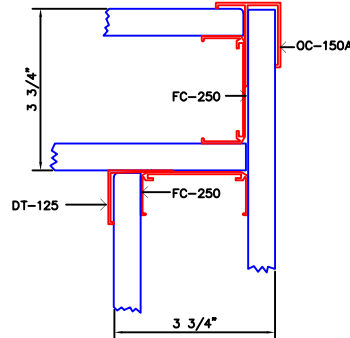

16 OUTSIDE CORNER

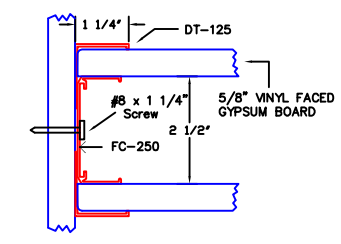

17 TERMINATION

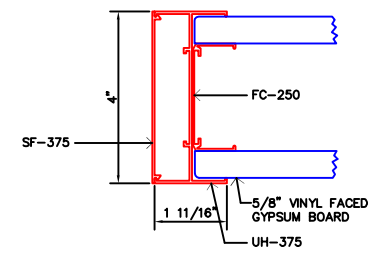

18 FINISHED END / UH-375

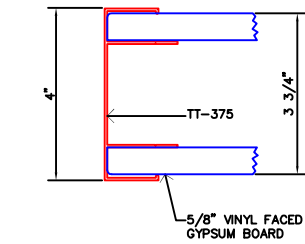

19 FINISHED END / TT-375

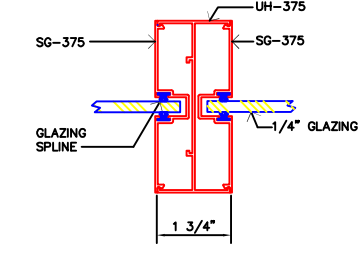

20 GLAZED MULLION

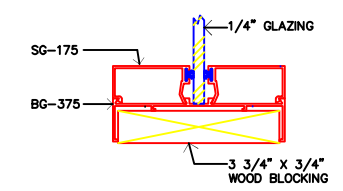

21 FULL GLAZING - NO BASE

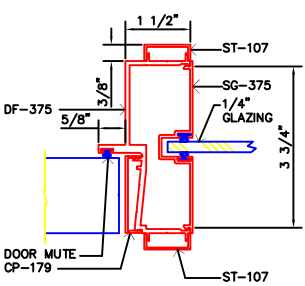

22 DOOR FRAME WITH GLASS TRANSITION

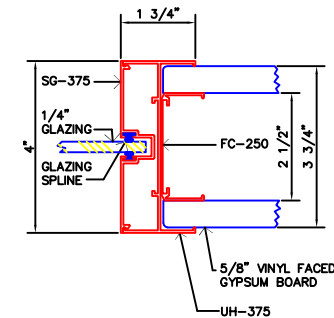

23 TRANSITION GLASS TO PANEL

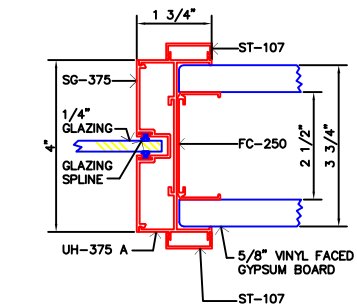

24 TRANSITION TO GLASS PANEL

